



PRODUCT SPECIFICATION

LCD Android Controller
HD-972S

Version: V2.3

Update History

Version	Release time	Description
V2.3	Nov. 5, 2025	V-by-One screen maximum display effect update
V2.2	Jan. 2, 2024	Update V-by-One Interface Definition Description.
V2.1	Oct. 13, 2023	Update content layout.
V1.1	Aug.30,2023	First official release.

Content

Chapter I Product Description	4
I . Overview	4
II . Features	4
Chapter II Product Specifications	5
I . Basic Parameters	5
1. Hardware Parameters	5
2. Software Parameters	7
II . Dimension Diagram	8
III. Product Diagram	9
IV. Interface Parameter Description	9
1. Power Interface Description	9
2. MIC (Microphone) Interface Description	10
3. LED/IR (remote control) Interface Definition	10
4. LVDS BL (LVDS Backlight) Interface Description	11
5. LVDS Interface Description	11
6. V-by-One Interface Description	13
7. USB Interface Description	15
8. SPK (amplifier) Interface Description	15
9. L/R (audio) Interface Description	16
10. GPIO Interface Description	16
11. UART (serial port) Interface Description	17
12. DEBUG Interface Description	17
13. 4 PIN RJ45 (Ethernet) Interface Description	18
14. CTP Interface Description	18
15. KEY Interface Description	19
16. Other Interface Description	19
Chapter III Communication Methods	20
I . Wi-Fi Update Program	20
II . U-disk Update Program	20
III. TF card Update Program	21
IV. Network Cable Update Program	21
V . Internet Update	22
Chapter IV Appendix: Product Appearance	22

Chapter I Product Description

I . Overview

HD-972S is a well-built all-in-one motherboard, adopting Amlogic T972 quad-core Cortex-A55 processor, equipped Android 9.0 system, the main frequency can reach up to 1.9 GHz, with super performance. Use Mali-G31 GPU, support AFBC (frame buffering from compression), 4K, H.265 hard decoding, 1080P video decoding, V-by-One interface 4K output, 4K level video playback. Support infrared remote control, Wi-Fi, RJ45 and so on. It is widely used in intelligent control fields such as advertising machines, interactive all-in-one machines, security, medical care, transportation, finance, industrial control, etc., which can accelerate the product development cycle. Due to its hardware platform, Android, Intelligent features can be used on the main board of the intelligent terminal when human-computer interaction and network device interaction are required, which can be your best choice.

HD-972S Standard 2.4GHz frequency Wi-Fi Module (support optional 5GHz frequency), support Bluetooth 4.2.

II . Features

- High performance. T972 Chip with quad core ARM Cortex-A55 architecture, the main frequency can reach up to 1.9GHz, compared with the common single-core, dual-core, and quad-core solutions on the market. It has a qualitative leap in performance, can play high-definition video in various formats, and can handle complex interactive operations.
- High stability. T972 Android integrated board, in terms of hardware and software, adds its own unique technology to ensure the stability of the product, which can make the final product reach 7*24 unattended hours.
- High integration. T972 Android integrated board integrates Ethernet, V-by-One, Wi-Fi, Amplifier, TF Expansion Card, USB expansion port, IR remote control function, CTP, HDMI-IN, LVDS, backlight control, microphone and other functions, which greatly simplifies the design of the whole machine.
- High scalability. 5 USB ports (3 pins, 2 standard), 3 serial ports (UART1 Adjustable by hardware RS485, UART2 Adjustable by hardware RS232, MCU_UART serial port with MCU Burning port shared) +1 channel expandable debug serial port, 5 IO expansion port can expand more peripheral devices.
- High definition. Support various V-by-One, LVDS interface LCD display screen, supports cropping screens of various sizes and resolutions.
- Perfectly supports multi-point infrared touch, multi-point capacitive touch, multi-point nano-film touch, multi-point acoustic wave touch, multi-point optical touch.

Chapter II Product Specifications

I . Basic Parameters

1. Hardware Parameters

Hardware Specifications	
CPU	T972, Quad-core, Up to 1.9GHz, Android 9.0
GPU	Mali-G31 GPU Quad-core GPU
RAM/ Storage	Standard 2G+32G、 4G+32G
Network	Support RJ45 R/A Fast Ethernet Support Ethernet; Support 2.4GHz Wi-Fi; Optional 5GHz; Support Wi-Fi 802.11b/g/n Protocol; Support Bluetooth 4.2
Display interface	1 LVDS interface, supports 1080P output, compatible with 3.3V/5V/12V power supply 1-channel V-by-One interface (maximum horizontal display effect up to 4K, maximum vertical display effect up to 1080P), 2 HDMI IN channels, supporting 4K@30Hz Point to point input
Image rotation	Support 0° , 90° , 180° , 270° or manual rotation, optional gravity sensor module to achieve automatic rotation.
Audio	Support standard left and right channel line output; support 3.5mm audio output interface.
Amplifier	2 pcs output (8 Europe 5 watts dual studio amplifier output)
Microphone	Difference MIC input
Touch screen	Support USB Multi-point infrared touch, multi-point nano-film touch, multi-point acoustic wave touch, multi-point optical touch and so on.
RTC	Built-in real-time clock function

USB	1 piece USB-2.0 HOST, 1 piece USB2.0 OTG, 3 pcs USB ports (One of them is shared with 4G module).
Infrared	Infrared receiver, support infrared remote control function
LED	1* Power Status LED (green), 1* System LED (green, blinking by default)
Button	1*Upgrade Button
Serial port	3 serial ports (UART1 can adjust RS485 through hardware, UART2 can adjust RS232 through hardware, MCU_UART serial port is shared with MCU programming port), 1 channel DEBUG
GPIO	5-way IO input and output control, can do key scanning control
KEY	Support power on/off function, reserved reset, ADC function.
Power adapter	Input: AC100-240V.50-60HZ, Output: DC12V 1.5A (Requires surge voltage less than 18V, ripple voltage less than 100mV)
Storage humidity	10% ~ 90%, no condensation
Storage temperature	-40°C~70°C
Operating temperature	-20°C~70°C

2. Software Parameters

Software Specifications	
Operating System	Android 9.0
Audio	MP3, WMA, WAV, APE, FLAC, AAC, OGG, M4A, 3GPP and other formats
Video	Support H.265, H.264, VP8, MAV, WMV, AVS, H.263, MPEG4 and other video formats
Image	Support various image formats such as JPG, BMP, PNG
System Comes with Application Software	APK Installer, Email, Calculator, Browser, Recorder, Calendar, Settings, Clock, Video Player, Search, Contacts, Gallery, Download, Camera, Music, Explorer, etc.
Language	support multi-language
Input	Standard Android keyboard with optional third-party input method
System Management	Original ecological Android system, open root permissions, and can customize product development
	Real-time remote monitoring, system crash self-recovery, unattended 7 * 24 hours
	Support OTA remote upgrade; support U-disk upgrade
	Support boot animation definition
	Support server / stand-alone mode switching
System Watchdog	Support hard watchdog and software watchdog

II. Dimension Diagram

1. Bare Board Dimensions

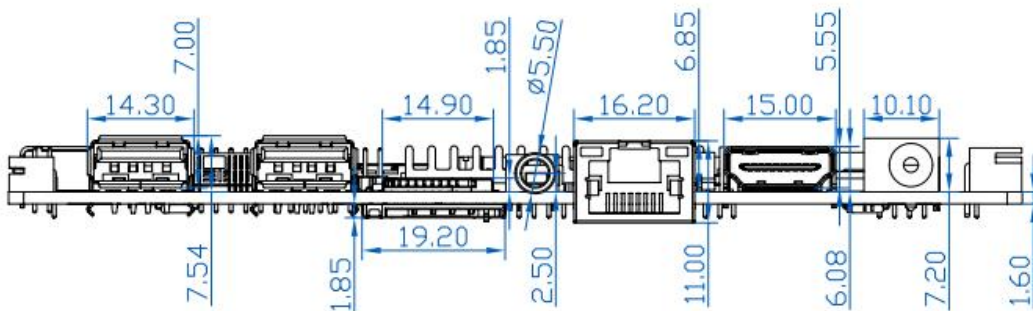
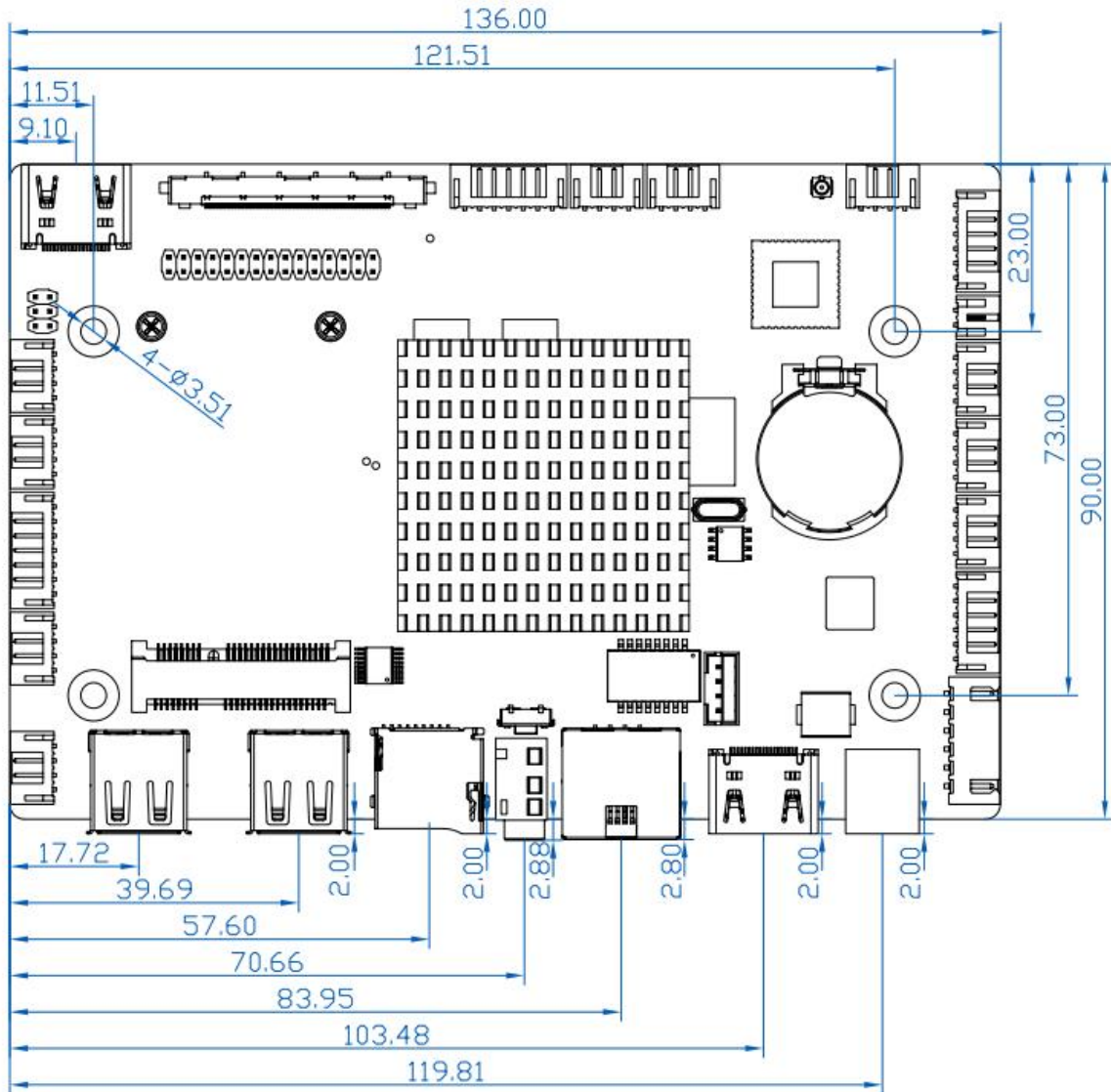

III. Product Diagram

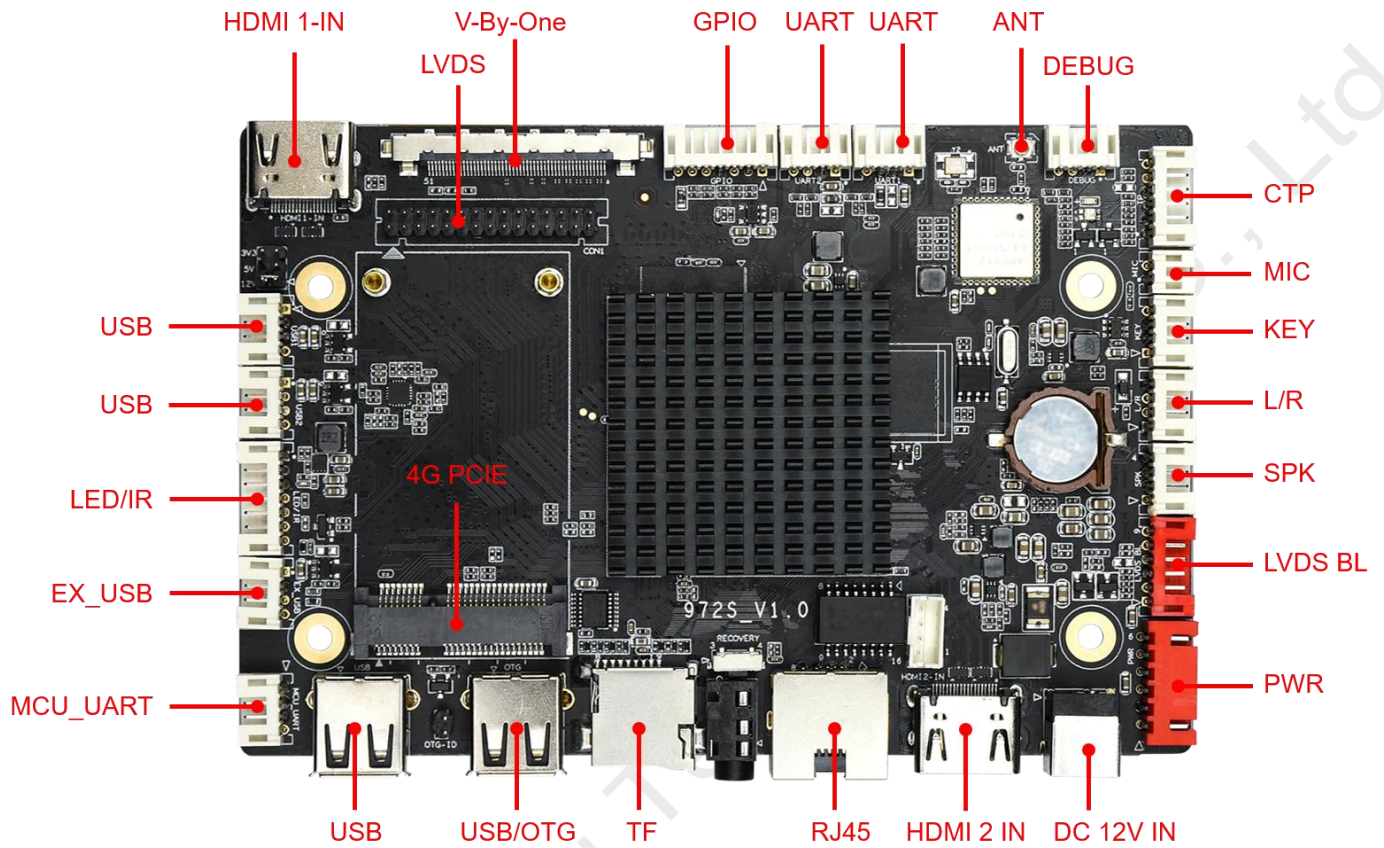

IV. Interface Parameter Description

1. Power Interface Description

Powered by 12V DC power supply, the board subsystem is only allowed to supply power from the DC socket and power socket.



No.	Definition	Attribute	Description
6	12V	input	12V input
5	12V	input	12V input
4	GND	ground wire	ground wire
3	GND	ground wire	ground wire
2	5VS	input	stand by 5V input
1	STB	output	stand by signal output

Note: The inner diameter of the DC power port is 2.0mm, and the outer diameter is 5.8mm.

2. MIC (Microphone) Interface Description



No.	Definition	Attribute	Description
1	MIC-P	input	MIC + input
2	MIC-N	input	MIC-input

3. LED/IR (remote control) Interface Definition



No.	Definition	Attribute	Description
1	RED	output	red indicator

2	3V3	power supply	3.3V output
3	GRN	output	green indicator
4	IO	output	remote control signal output
5	IR	input	remote control signal input
6	GND	ground wire	ground wire
7	3V3	power supply	3.3V output

4. LVDS BL (LVDS Backlight) Interface Description



No.	Definition	Attribute	Description
1	GND	ground wire	ground wire
2	GND	ground wire	ground wire
3	ADJ	output	backlight brightness control
4	EN	output	backlight brightness control
5	12V	power supply	12V output
6	12V	power supply	12V output

5. LVDS Interface Description



General LVDS interface definition, support single/dual, 6/8/10-bit 1080P LVDS screen. The screen voltage can be selected through the jumper cap, and the screen power supply can be selected to support 3.3V/5V/12V.

In order to avoid burning the board and screen, please pay attention to the following:

1. Please confirm whether the screen power supply voltage is correct, and whether the corresponding power supply of the board can meet the maximum current of the screen.

2.1. Please use a multimeter to confirm whether the power supply selected by the jumper cap is correct.

3. When connecting the screen cable of 6/8-bit LVDS screen, close to the pin1 end to connect and install.

No.	Definition	Attribute	Description
1	VCC	power supply	3.3V/5V/12V optional output
2	VCC		
3	VCC		
4	GND	ground wire	ground wire
5	GND	ground wire	ground wire
6	GND	ground wire	ground wire
7	RX00-	output	Odd 0-
8	RX00+	output	Odd 0+
9	RX01-	output	Odd 1-
10	RX01+	output	Odd 1+
11	RX02-	output	Odd 2-
12	RX02+	output	Odd 2+
13	GND	ground wire	ground wire
14	GND	ground wire	ground wire
15	RXOC-	output	Odd Clock-
16	RXOC+	output	Odd Clock+
17	RX03-	output	Odd 3-
18	RX03+	output	Odd 3+
19	RXE0-	output	Even 0-
20	RXE0+	output	Even 0+
21	RXE1-	output	Even 1-
22	RXE1+	output	Even 1+

23	RXE2-	output	Even 2-
24	RXE2+	output	Even 2+
25	GND	ground wire	ground wire
26	GND	ground wire	ground wire
27	RXEC-	output	Even Clock-
28	RXEC+	output	Even Clock+
29	RXE3-	output	Even 3-
30	RXE3+	output	Even 3+

6. V-by-One Interface Description



No.	Definition	Attributes	Describe
1	GND	ground wire	ground wire
2	VBX-7P	output	Pixel0 Positive Data
3	VBX-7N	output	Pixel0 Negative Data
4	GND	ground wire	ground wire
5	VBX-6P	output	Pixel1 Positive Data
6	VBX-6N	output	Pixel1 Negative Data
7	GND	ground wire	ground wire
8	VBX-5P	output	Pixel2 Positive Data
9	VBX-5N	output	Pixel2 Negative Data
10	GND	ground wire	ground wire
11	VBX-4P	output	Pixel3 Positive Data
12	VBX-4N	output	Pixel3 Negative Data
13	GND	ground wire	ground wire
14	VBX-3P	output	Pixel4 Positive Data
15	VBX-3N	output	Pixel4 Negative Data
16	GND	ground wire	ground wire
17	VBX-2P	output	Pixel5 Positive Data

18	VBX-2N	output	Pixel5 Negative Data
19	GND	ground wire	ground wire
20	VBX-1P	output	Pixel6 Positive Data
21	VBX-1N	output	Pixel6 Negative Data
22	GND	ground wire	ground wire
23	VBX-0P	output	Pixel7 Positive Data
24	VBX-0N	output	Pixel7 Negative Data
25	GND	ground wire	ground wire
26	LOCKN-OUT	output	CLOCK
27	HTPDN	output	TCON
28	SEL		TCON
29	AGP		TCON
30	SCN-EN		TCON
31	Bit-SEL		TCON
32	LD-EN2		TCON
33	BOE-SCL		TCON
34	BOE-SDA		TCON
35	2D/3D		TCON
36	L/R-IN		TCON
37	L/R OUT		TCON
38			NC
39	GND	ground wire	ground wire
40	GND	ground wire	ground wire
41	GND	ground wire	ground wire
42	GND	ground wire	ground wire
43			NC
44	VCC-VX1	Power	Power
45	VCC-VX1	Power	Power
46	VCC-VX1	Power	Power
47	VCC-VX1	Power	Power
48	VCC-VX1	Power	Power
49	VCC-VX1	Power	Power
50	VCC-VX1	Power	Power
51	VCC-VX1	Power	Power

Note: Do not operate with power on, Do not hot swap

7. USB Interface Description



The board has 2 USB standard interfaces and 3 USB pins, one of which is shared with the 4G module.
 USB ports

No.	Definition	Attribute	Description
1	5VS	power supply	5V output
2	DM	input/output	DM
3	DP	input/output	DP
4	GND	ground wire	ground wire

8. SPK (amplifier) Interface Description



No.	Definition	Attribute	Description
1	OUTP-R	output	right channel+
2	OUTN-R	output	right channel-
3	OUTN-L	output	left channel-
4	OUTP-L	output	left channel+

9. L/R (audio) Interface Description



No.	Definition	Attributes	Describe
1	LO-L	output	left channel
2	LO-R	output	right channel
3	GND	ground wire	ground wire
4	NC	NC	undefined

10. GPIO Interface Description



No.	Definition	Attributes	Describe
1	GND	ground wire	ground wire
2	K5	K5	K5
3	K4	K4	K4
4	K3	K3	K3
5	K2	K2	K2
6	K1	K1	K1
7	3V3	power supply	3.3V output

11. UART (serial port) Interface Description

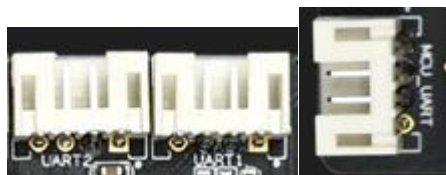

The board leads out two groups of common UART serial ports, which can support common UART serial port devices on the market.

Tips:

1. Whether the serial port voltage matches. Cannot directly access RS232, RS485 serial device.
2. Whether the connection of TX and RX is correct.

No.	Definition	Attributes	Describe
1	VCC	power supply	3.3V output, optional 5V
2	TX	output	TX
3	RX	input	RX
4	GND	ground wire	ground wire

1. UART1 can be adjusted by hardware RS485
2. UART2 can be adjusted by hardware RS232
3. MCU_UART serial port is shared with MCU programming port

12. DEBUG Interface Description



No.	Definition	Attributes	Describe
1	3V3	power supply	3.3V output
2	TX	output	TX
3	RX	input	RX
4	GND	ground wire	ground wire

13. 4 PIN RJ45 (Ethernet) Interface Description



No.	Definition	Attributes	Describe
1	TXP	output	output+
2	TXN	output	output-
3	RXP	input	input+
4	RXN	input	input-

14. CTP Interface Description



No.	Definition	Attributes	Describe
1	3V3	power supply	3.3V output
2	SCL	input/output	I2C clock
3	SDA	input/output	I2C data
4	INT	input/output	interrupt
5	RST	input/output	reset
6	GND	ground wire	ground wire

15. KEY Interface Description

No.	Definition	Attributes	Describe
1	PWRON	switch	power on, power off
2	RESET	reset signal	reset signal interface
3	ADC	ADC	ADC
4	GND	ground wire	ground wire

16. Other Interface Description

Storage interface	TF card	data storage, maximum support 256G
	USB	HOST interface, support data storage, data import, USB mouse and keyboard, camera, touch screen, etc.
Ethernet interface	RJ45 interface	support 100M wired network
HDMI IN interface	standard interface	support HDMI input, up to 1080P
3G/4G	PCI-E standard interface	all kinds support
SIM card interface	standard interface	support various formats (depending on 4G module)

Chapter III Communication Methods

I . Wi-Fi Update Program

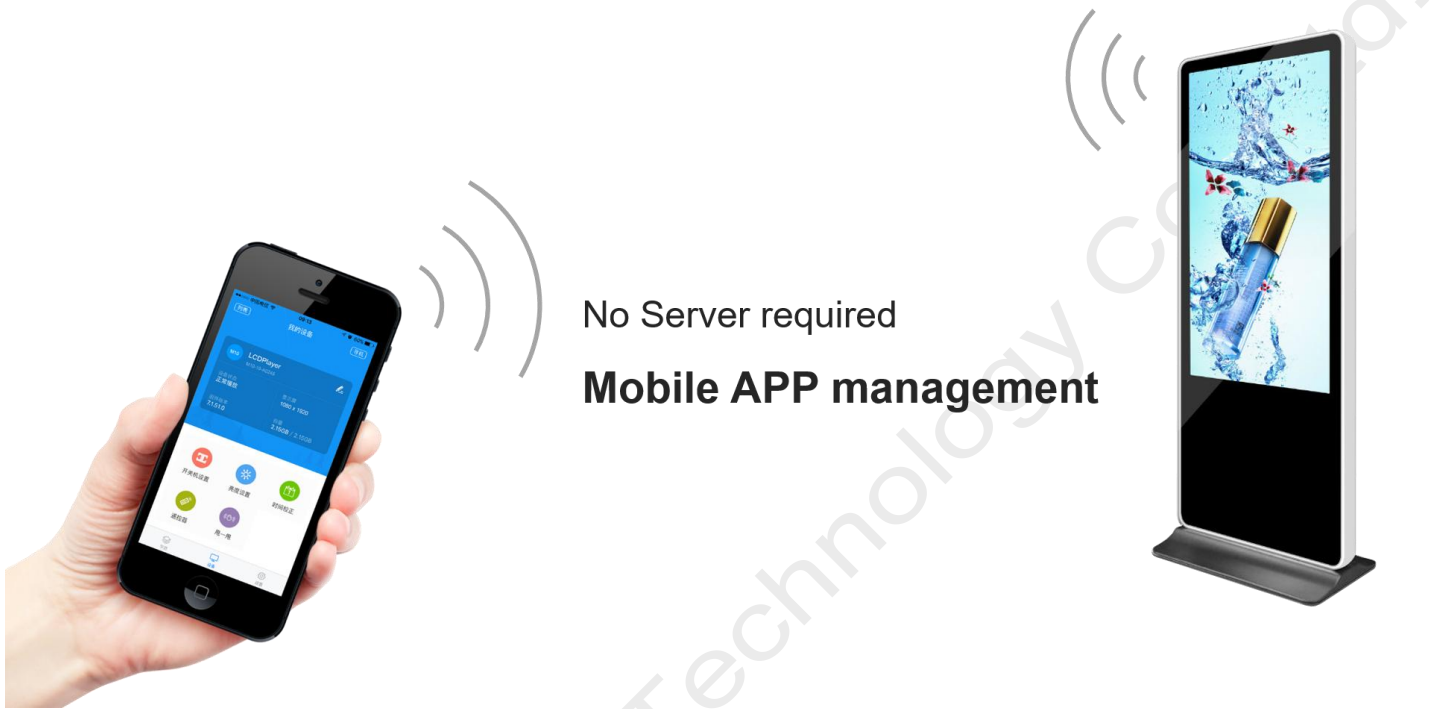

II . U-disk Update Program



U-disk update programs

Support Interstitial & memory expansion

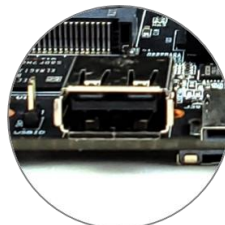

III. TF card Update Program



TF card update programs

Support Interstitial & memory expansion



IV. Network Cable Update Program

LAN or Internet

Network cable connection

LAN & Internet integrated management

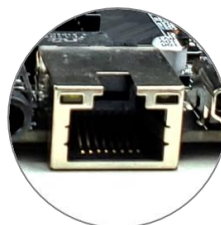

V. Internet Update

Internet remote management

Anytime & anywhere operation available

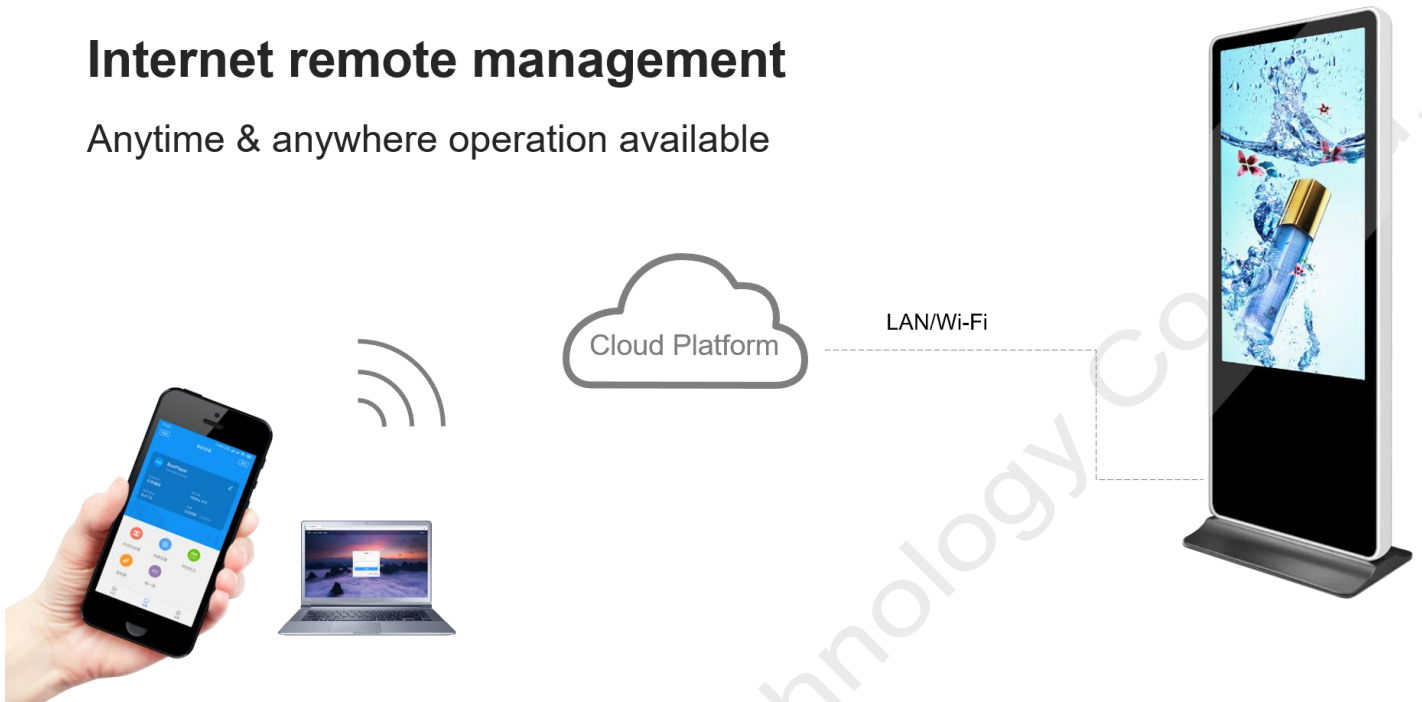

Chapter IV Appendix: Product Appearance

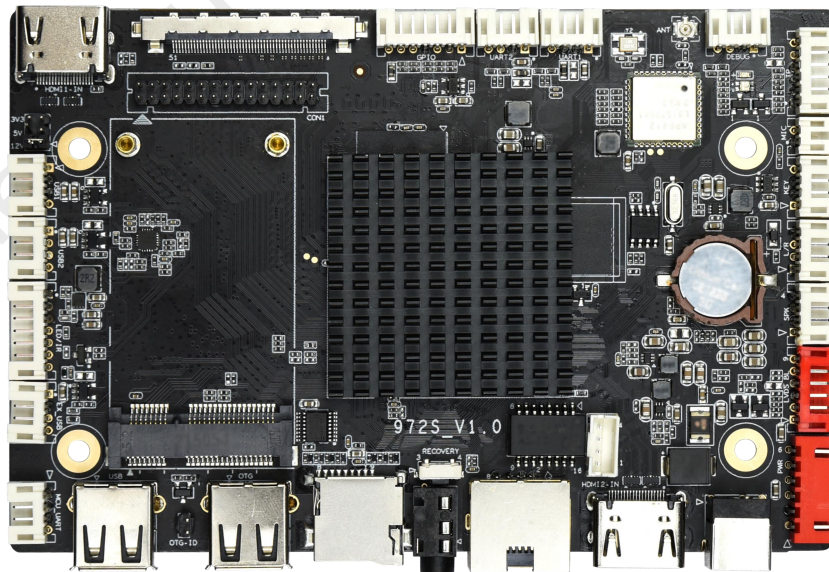

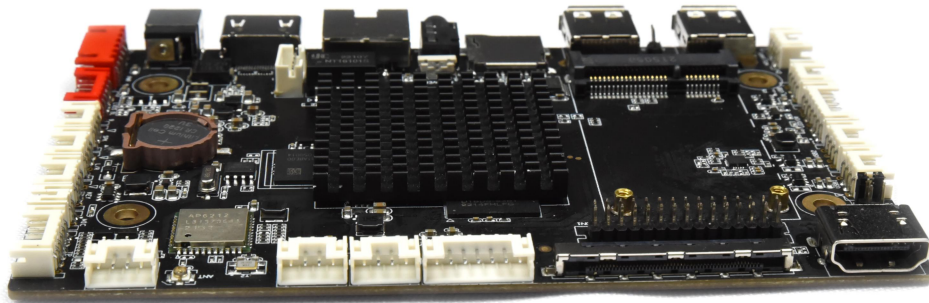

Note:

1. Paste the corresponding model label on the sales product. Some difference between the product picture in the specification and the actual product, not a fake or inferior product. If you have any questions, please contact HUIDU Technology for confirmation.
2. **Do not operate with power on, Do not hot swap.**